

# Telex

---

## Operating Instructions

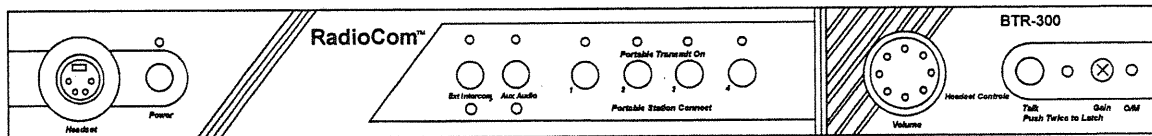

**RadioCom™**

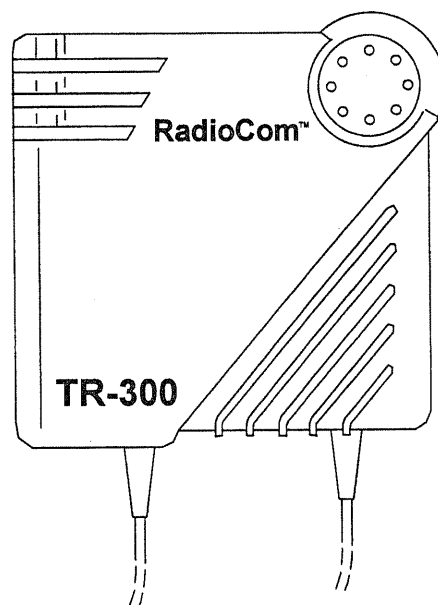

**PROFESSIONAL  
WIRELESS  
INTERCOM SYSTEM  
TR-300, BTR-300**

---

**TELEX®**

---

# TABLE OF CONTENTS

<b>INTRODUCTION</b> .....	1
GENERAL DESCRIPTION .....	1
<b>BTR-300 BASE STATION TRANSCEIVER</b> .....	3
SPECIFICATIONS .....	3
FEATURES .....	4
CONTROLS AND CONNECTIONS .....	5
<b>TR-300 BELT-PACK TRANSCEIVER</b> .....	9
SPECIFICATIONS .....	9
FEATURES .....	10
CONTROLS AND CONNECTIONS .....	10
<b>EQUIPMENT SET-UP</b> .....	13
BTR-300 SET-UP .....	13
ANTENNA INFORMATION .....	16
<b>TR-300 SET-UP</b> .....	23
<b>PRE-WALK-THRU CHECKLIST</b> .....	24
<b>SYSTEM OPERATION</b> .....	25
BTR-300 OPERATION .....	25
TR-300 OPERATION .....	26
ENABLING AUDIO .....	27
SETTING SYSTEM GAIN LEVELS .....	28
<b>SYSTEM WALK-THRU</b> .....	29
<b>TROUBLESHOOTING</b> .....	30
<b>BATTERY INFORMATION</b> .....	31
<b>ACCESSORIES</b> .....	33
<b>CUSTOMER SERVICE INFORMATION</b> .....	34
<b>FCC INFORMATION</b> .....	35

# INTRODUCTION

## GENERAL DESCRIPTION

This manual covers the BTR-300 Base Station and the TR-300 Portable Transceiver.

The RadioCom Models BTR-300 and TR-300 were specifically designed to provide the user with a highly flexible wireless two-way communication system with the capability to interface with a wired intercom system and other auxiliary audio.

At the BTR-300 operator's command, the remotes may communicate with each other, with a wired intercom system or with an auxiliary system. The BTR-300 Base Station with its one transmit and four receive channels is designed to operate in full duplex (simultaneous two-way communications) with up to four TR-300 Belt Pack transceivers. See block diagram in Figure 1.

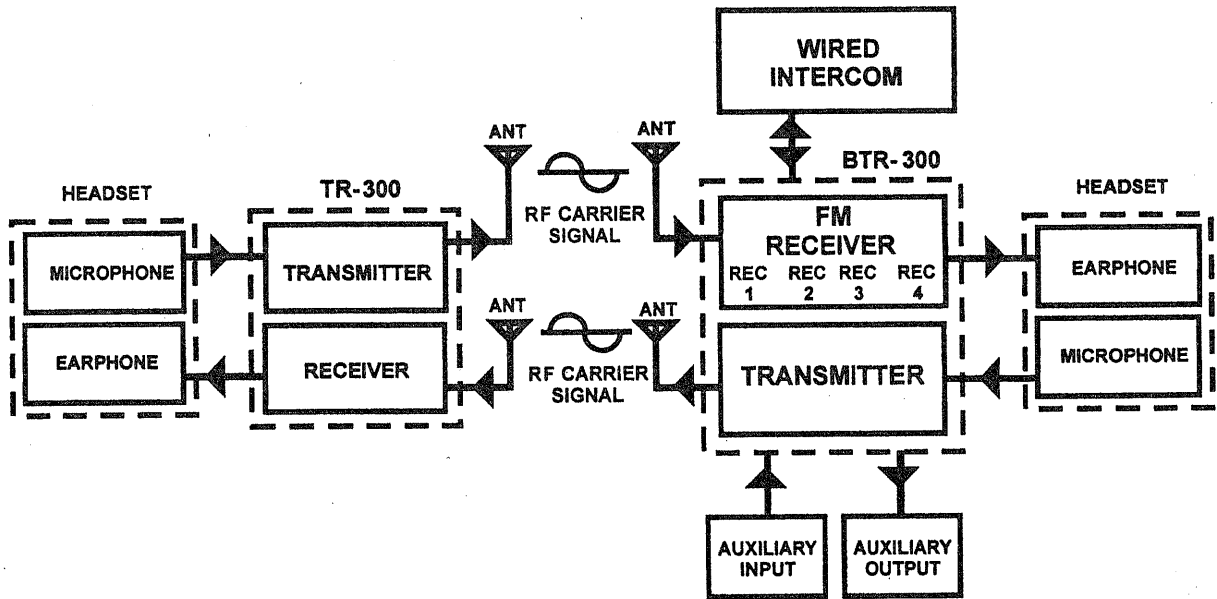

Figure 1  
Block Diagram of System

The system operates on selected frequencies within the 150-216 MHz band.

The BTR-300 system is fully compatible with a number of other wired intercom manufacturers units. See the BTR-300 Setup Section for additional information.

The TR-300 Transceiver operates in the continuous transmit mode with the audio activated by a switch. As many as four TR-300 belt-pack transceivers can operate in a fully duplex network with one RadioCom Model BTR-300 Base Station.

# BTR-300 BASE STATION TRANSCEIVER

## TECHNICAL INFORMATION

### SPECIFICATIONS BTR-300

Input Power (minimum)	12V AC/DC at 360 mA
Intercom Output	330 mV (Low) or 1 V (Hi) RMS into 300 ohm load typical (at rated deviation)
Intercom Input (Gain Minimum)	300 mV RMS typical (for rated deviation)
Auxiliary Output	2 V RMS into 600 ohm load typical (at rated deviation)
Auxiliary Input (Gain Maximum)	60 mV RMS typical (for rated deviation)
Local Headset Input	2 mV RMS input nominal 1.5 mV RMS input at compression (Dynamic)
Local Headset Output	32 mV maximum output into 600 ohms
Temperature Range	-4°F to 130°F (-20°C to 55°C)
Dimensions	15.75" W x 1.75" H x 10.5" D (40 cm x 4.5 cm x 26 cm)
Weight	4.5 lbs (2 kg)

### Transmit

RF Frequency Range	150-216 MHz
RF Frequency Stability	Crystal Controlled, 0.005%
RF Power Output	50 mW Typical
Modulation	FM, 3 KHz deviation. 115 micro-seconds Pre-emphasis
Transmit Antenna	5/8-wave (supplied) SO239 connector on chassis
Modulation Limiter	Internal Compressor
Modulation Frequency Range	300 to 5000 Hz $\pm$ 2 dB
Radiated Harmonics and Spurious Emissions	-45 dBC, Exceeds FCC Specifications
FCC	Type Accepted Under Parts 90 and 74

## SPECIFICATIONS BTR-300 (Cont.)

### Receive

RF Frequency Range .....	150-216 MHz
RF Frequency Stability .....	Crystal Controlled, 0.005%
Type .....	Dual conversion superheterodyne, FM
RF Sensitivity .....	Less than 0.5 $\mu$ V for 12 dB SINAD
IF Selectivity .....	3 dB at 30 kHz (4 pole Monolithic Filter)
Image Rejection .....	.65 dB or better
Squelch Quieting .....	.90 dB
Squelch Threshold .....	1.0 $\mu$ V (Internal)
Signal-to-Noise Ratio .....	.90 dB
Receive Antenna .....	.5/8-wave (supplied) SO239 connector on chassis
Distortion .....	Less than 1% at Rated Output

### FEATURES

The RadioCom Model BTR-300 is a Base Station with one transmitter and four receivers. It is designed for portable two way communication with the capability for interface to other audio systems. Features include:

- An extremely flexible unit that has the capability to communicate at one time with up to four portable stations and wired stations (intercom and/or other audio source).
- Powered by an external AC supply via the power jack on the rear of the unit. It can also be powered by any 12V AC/DC 700 mA source.

- Intercom connections with the ability to interface with most wired intercom systems.
- RF light indicator for each portable station.
- All metal case for superior shielding.
- Table or rack mountable.

## CONTROLS and CONNECTIONS

### FRONT PANEL (Refer to Figure 3)

**Power ON/OFF Switch:** Push this switch once to turn power ON; push it again to turn the power OFF.

**Power ON Indicator:** The Power On light is illuminated when the Power ON/OFF Switch is pushed in the ON Position.

**Local Headset Connector:** 4 Pin XLR Connector for Input/Output. The headset jack will accept many Telex model headsets. Compatible with other intercom headsets with four pin XLR connectors that are wired as shown in Figure 2.

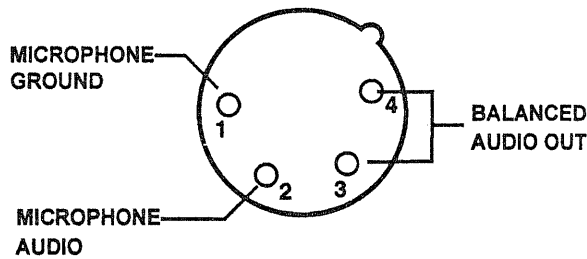

Figure 2  
Headset XLR Connector Wiring

**Local Headset Volume:** Adjusts volume to Local Headset. **DOES NOT AFFECT MICROPHONE GAIN.**

**Mic On-Push-to-Talk/Lock-to-Talk Switch:** Enables the local headset microphone audio function.

**NOTE: DOES NOT** control base station RF transmit.

**Local Push-to-Talk Indicator:** Will be illuminated whenever the talk function is on.

**Local Microphone Gain Control and Overmodulation Indicator:** A screwdriver adjustable control is provided to control the input level of the local headset mic. This input is protected from overloads by means of a gain compressor whose operation is signaled by the gain light indicator.

**Portable Enable Switches and Indicators:** When in the "IN" position, the Enable switches allow the user of the corresponding portable unit to be heard by others connected to the system. When in the "OUT" position, the respective portable will be muted, but this portable will still be able to hear all other selected remotes and interfaces. The indicators (Portable Transmit On) normally show the presence of a portable transceiver in use on the channel corresponding to that indicator.

**External Intercom Switch, Level Control, and indicator:** This switch enables the wired intercom interface when "IN", and disables it when "OUT". For RTS intercoms, the "IN" position is channel 1 and the "OUT" position is channel 2. A screwdriver adjustable control is provided to control the input level of the wired intercom.

**Auxiliary Audio Enable Switch, Level Control, and Indicator:** The switch enables and disables the Auxiliary interface when "IN" and "OUT", respectively. The function of the level control here is the same as that described for the intercom.

#### **REAR PANEL (Refer to Figure 4)**

**Transmit and Receive Antenna Connectors:** Attach 5/8-wave antennas (supplied) to these connectors; Antenna color should match the "color dot."

**Transmit Switch:** Slide switch that allows the operator to select one of three transmit modes. In the "OFF" position, the transmitter is always off. This mode may be used if the base is functioning solely as a monitor. In the "CONT" position, the transmitter is always on. This continuous mode is recommended over the "REMOTE" mode. In the "REMOTE" position, the transmitter is enabled only when one or more portables are active.

**Headset Microphone Select Switch:** This switch allows the user to select either an Electret or Dynamic microphone.

**Intercom Connectors:** Connections to interface the BTR-300 with a wired intercom system.

**Auxiliary Output/Input Connectors:** Can be used for 2-way (four wire) input and output to the BTR-300 or as a simplex input or output. Typical uses are 4 wire intercom's, tape recorders, public address inputs or outputs.

**Power Jack:** For external AC supply adaptor (supplied).

**Speaker Jack:** Allows the use of an external monitor if desired. An 8 ohm speaker is recommended.

**Speaker Volume Control:** Screwdriver adjustable. Adjust clockwise to increase speaker volume or counterclockwise to decrease speaker volume.

**NOTE:** Leave setting counterclockwise if no speaker is attached.



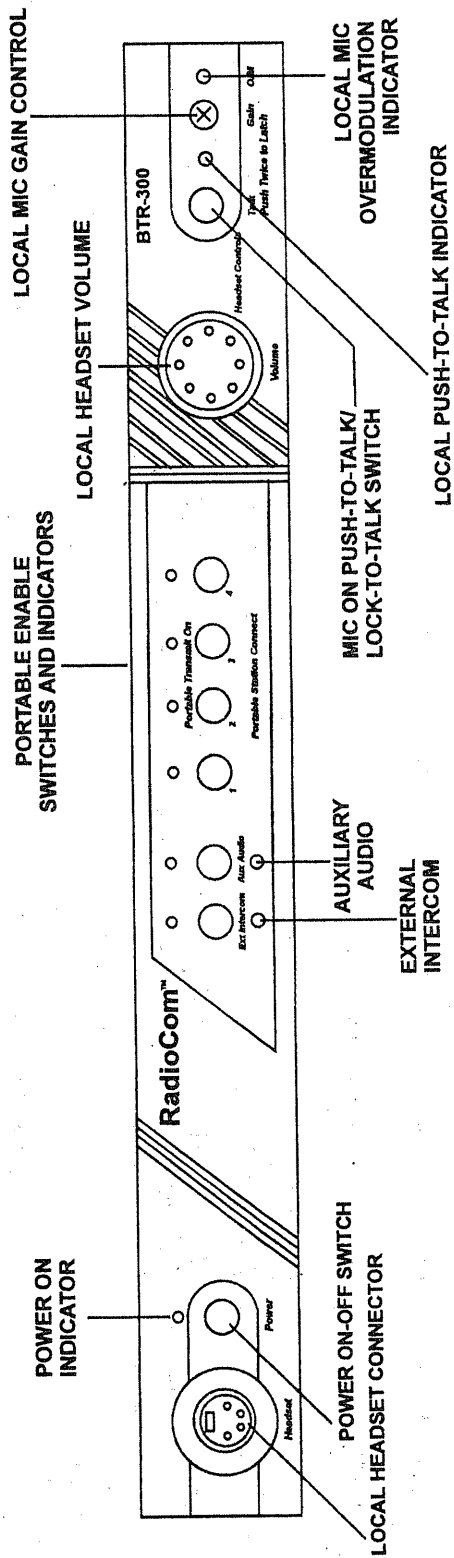

Figure 3  
Front Panel BTR-300

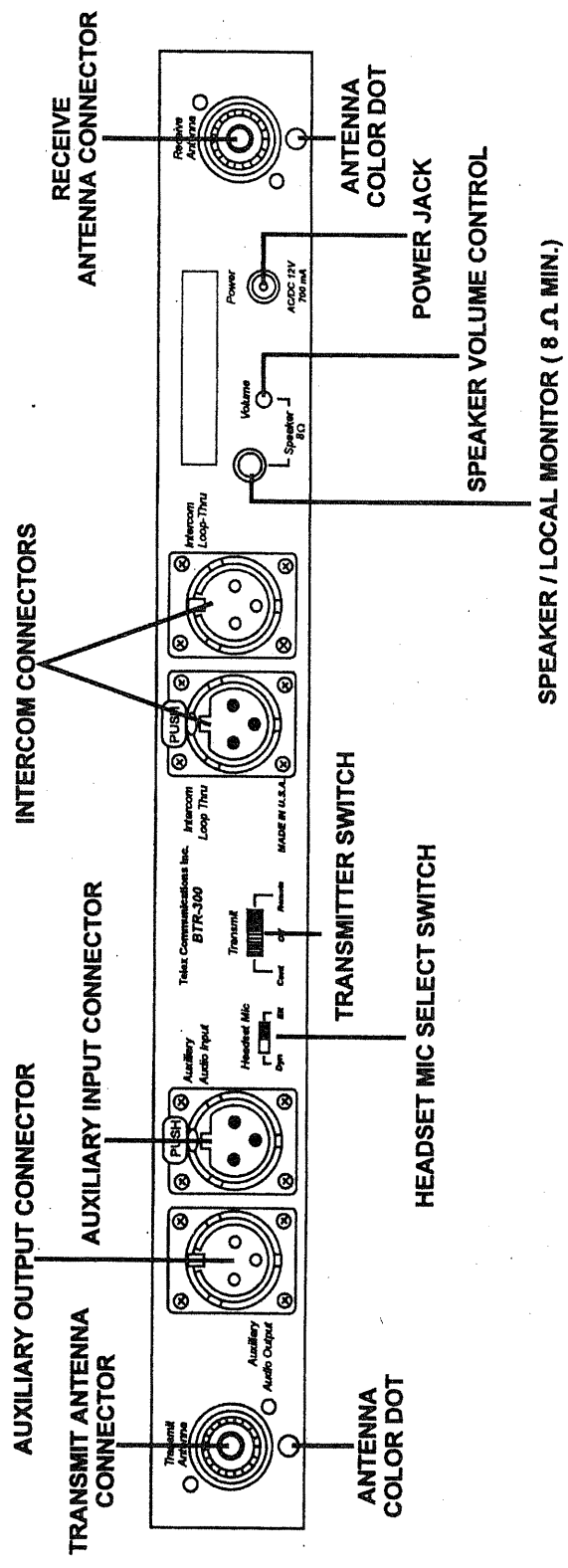

Figure 4  
Rear Panel BTR-300

# TR-300 BELT-PACK TRANSCEIVER

## TECHNICAL INFORMATION

### SPECIFICATIONS TR-300

#### Overall

Power Requirements	6 AA cells (Alkaline, NEDA, MN 1500) Nickel-metal hydride optional
Current Drain	typical 82 mA
Temperature Range	-4°F to 130°F (-20°C to 55°C)
Dimensions	4.25" W x 4.125" H x 2.0" D (108mm x 105mm x 51 mm)
Weight	13 oz. (369g) with batteries
Transmit Antenna	1/4-wave wire (attached)
Receive Antenna	1/4-wave wire (attached)

#### Transmit

RF Frequency Range	150-216 MHz
RF Frequency Stability	Crystal Controlled, 0.005%
RF Power Output	50 mW Typical
Modulation	FM, 3000 Hz deviation, 115 micro-seconds Pre-emphasis
Modulation Limiter	Internal Compressor
Modulation Frequency Range	300 to 5000 Hz +/- 2 dB
Microphone Audio Input	30 to 3500 ohms
Microphone Input Sensitivity	2 mV Dynamic, 4 mV Electret
Radiated Harmonics and Spurious Emissions	-45 dBC, Exceeds FCC Specifications
FCC	Type Accepted Under Parts 90 and 74

#### Receive

RF Frequency Range	150-216 MHz
RF Frequency Stability	Crystal Controlled, 0.005% Type Dual Conversion Superheterodyne, FM
RF Sensitivity	Less than 0.5 $\mu$ V for 12 dB SINAD
IF Selectivity	3 dB at 30 kHz (Ceramic Filter)
Image Rejection	70 dB or better
Squelch Quieting	90 dB
Squelch Threshold	3.0 $\mu$ V (Internal)
Signal-to-Noise Ratio	90 dB
Audio Output	32 mW into 600 ohms (Headset)
Distortion	Less than 1% at Rated Output

## FEATURES

- Lightweight, small size and is self-contained.
- 2 separate antennas, one for transmit, the other for receive.
- Push-to-Talk with Lock-to-Talk feature switch for the TR-300 and Push-to-Transmit with Lock-to-Transmit feature for the TR-300P.

## CONTROLS AND CONNECTIONS

### EXTERNAL CONTROLS (Refer to Figure 6)

**Volume OFF/ON Control:** This thumbwheel control serves as both an off/on switch and as a volume control.

### Low Battery and Overmodulation Indicator Light:

**Low Battery Indicator:** Part of the battery check circuit. When the power switch is placed in the "ON" position the light will flash one or more times if the battery is good. A poor battery will cause the light to illuminate continuously and a bad or unusable battery will not cause any illumination at all.

**Overmodulation Indicator:** Uses the same light as the low battery indicator. During the talk mode, if the microphone gain is too high, the light will illuminate when talking.

**Push-To-Talk, Lock-To-Talk Switch:**  
This switch enables the talk function.

**Talk Indicator Light:** (Labeled "talk") will be illuminated whenever the talk function on the TR-300 is enabled.

**Headset Jack:** A four pin XLR connector for Input/Output. The headset jack will accept many different Telex model headsets. Compatible with other intercom headsets with four pin XLR connectors that are wired as shown in Figure 5.

**Charge Jack:** Allows nickel-metal hydride batteries to be charged without removing them from the unit.

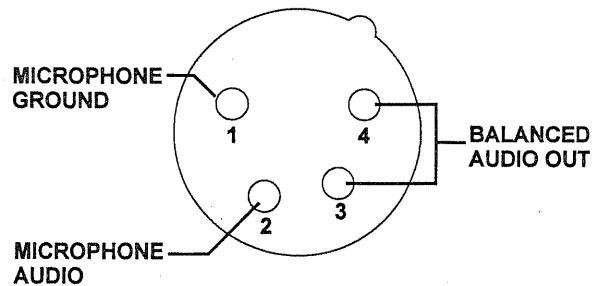

**Figure 5**  
**Headset XLR Connector Wiring**

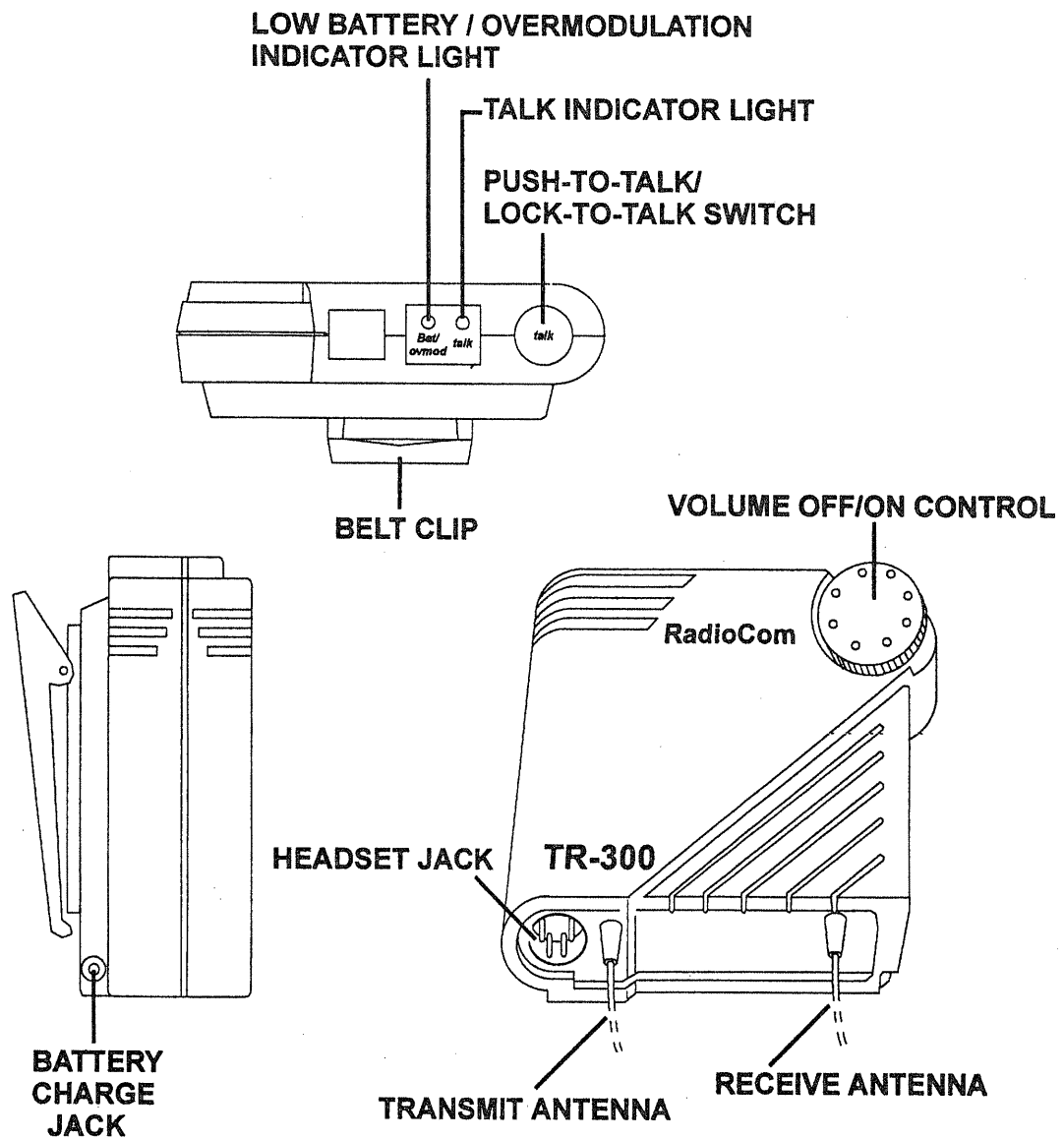

**Figure 6**  
**External Controls, TR-300**

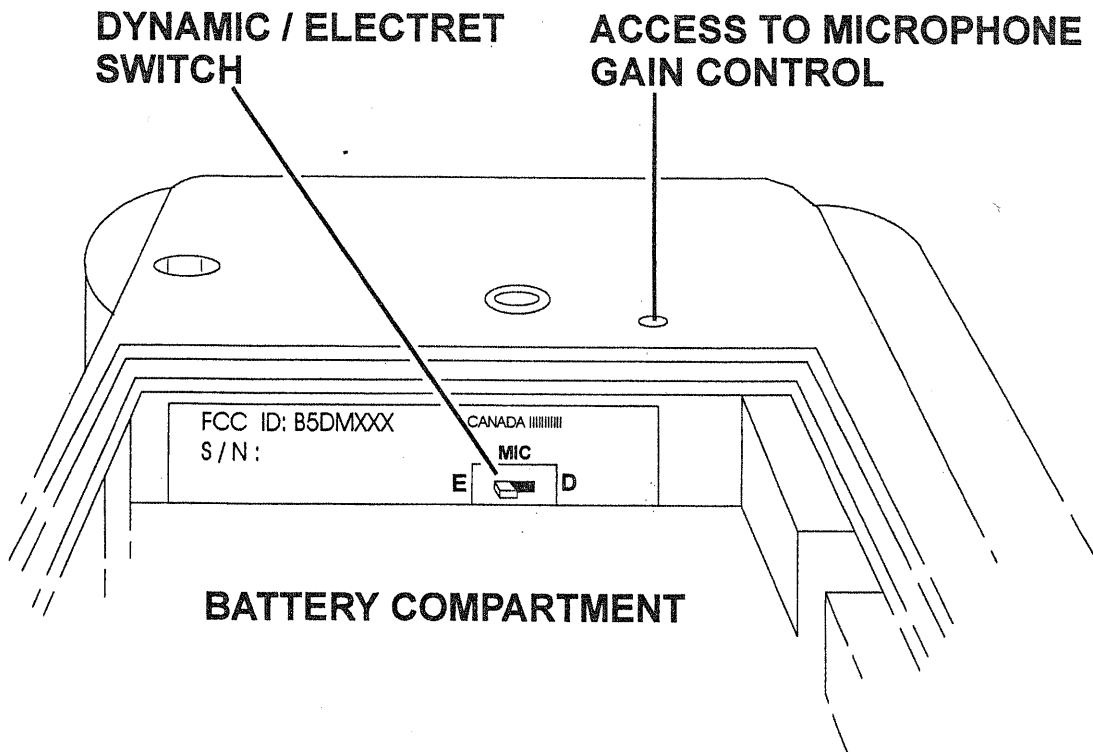

Figure 7  
Internal controls, TR-300

**INTERNAL CONTROLS (Refer to Figure 7)**

**Microphone Gain Control:** Screwdriver adjustable by removing belt clip and prying out the small rubber plug to the right of the screw boss.

**Dynamic/Electret Switch:** This switch allows selection of “D” when using a Dynamic Microphone or “E” when using an Electret Microphone.

**Battery Compartment:** Holds 6 AA batteries in a removable battery holder (supplied).

# EQUIPMENT SET-UP

## BTR-300 SET-UP

### UNPACKING

Unpack your BTR-300 and TR-300 Systems. If there are any damages or shortages, refer to the "Warranty Service Information" section in this manual.

### INTERNAL INTERCOM SWITCHES

The BTR-300 has internal switches that allow it to accommodate intercom systems other than what it was set to interface with when manufactured. Product No. 71276XXXX is set for Telex Audio Com and similar systems. Product No. 71280XXXX is set for RTS 2 wire and similar systems. Units originally set for Telex may be set to RTS and vice versa. Both models may be set to interface with Clearcom, and 4 wire RTS/McCurdy matrix type systems. The following paragraphs explain how to change the switches if necessary.

**Remove Cover:** Remove the cover screws (13) and lift off the cover.

**DIP Switch:** See Figure 8 and Table 1. Set the DIP switch as shown in the table.

**High/Low Switch:** See Figure 8 and Table 2. Set the high/low switch as shown in the table.

**Intercom Switch:** See Figure 8 and Table 2. Set the switch to 2 wire for all 2 wire systems. Set the switch to 4 wire if the BTR is to be connected to a balanced 4 wire intercom system through the Auxiliary input and output jacks.

**Note:** Do not connect both 4 wire and 2 wire systems at the same time. Loud feedback may result.

**Replace Cover:** Carefully align the cover and replace the screws.

### INTERCOM JACK WIRING CONFIGURATIONS

See Table 3 for the wiring of the intercom and auxiliary jacks.

DIP SWITCH POSITION									
	1	2	3	4	5	6	7	8	9
Telex Audiocom	ON	ON	OFF	ON	OFF	ON	OFF	OFF	ON
RTS 2 wire	OFF	OFF	ON	OFF	ON	OFF	ON	ON	OFF
Clearcom	ON	OFF	ON	ON	OFF	OFF	OFF	ON	ON
4 Wire	N/A	N/A	N/A	N/A	N/A	N/A	N/A	N/A	N/A

Table 1

INTERCOM TYPE	LOW/HIGH SWITCH	INTERCOM SWITCH
Telex Audio Com	Low	2 wire
RTS	High	2 wire
Clearcom	Low	2 wire
4 wire	N/A	4 wire

Table 2

Internal Switch Settings	Auxiliary Audio Out			Auxiliary Audio Input			Intercom Loop Thru (both jacks)		
	Pin 1	Pin 2	Pin 3	Pin 1	Pin 2	Pin 3	Pin 1	Pin 2	Pin 3
Telex Audio Com	Ground	600 ohm Balanced	600 ohm Balanced	Ground	2.2K ohm Balanced	2.2K ohm Balanced	Ground	Balanced	Balanced
RTS 2 wire	Ground	600 ohm Balanced	600 ohm Balanced	Ground	2.2K ohm Balanced	2.2K ohm Balanced	Ground	Channel 1	Channel 2
Clearcom	Ground	600 ohm Balanced	600 ohm Balanced	Ground	2.2K ohm Balanced	2.2K ohm Balanced	Ground	Power	Audio
4 wire	Ground	Balanced Intercom Out	Balanced Intercom Out	Ground	Balanced Intercom In	Balanced Intercom In	Do Not Use	Do Not Use	Do Not Use

**Table 3**  
**Pin Wiring for Rear Panel Jacks**

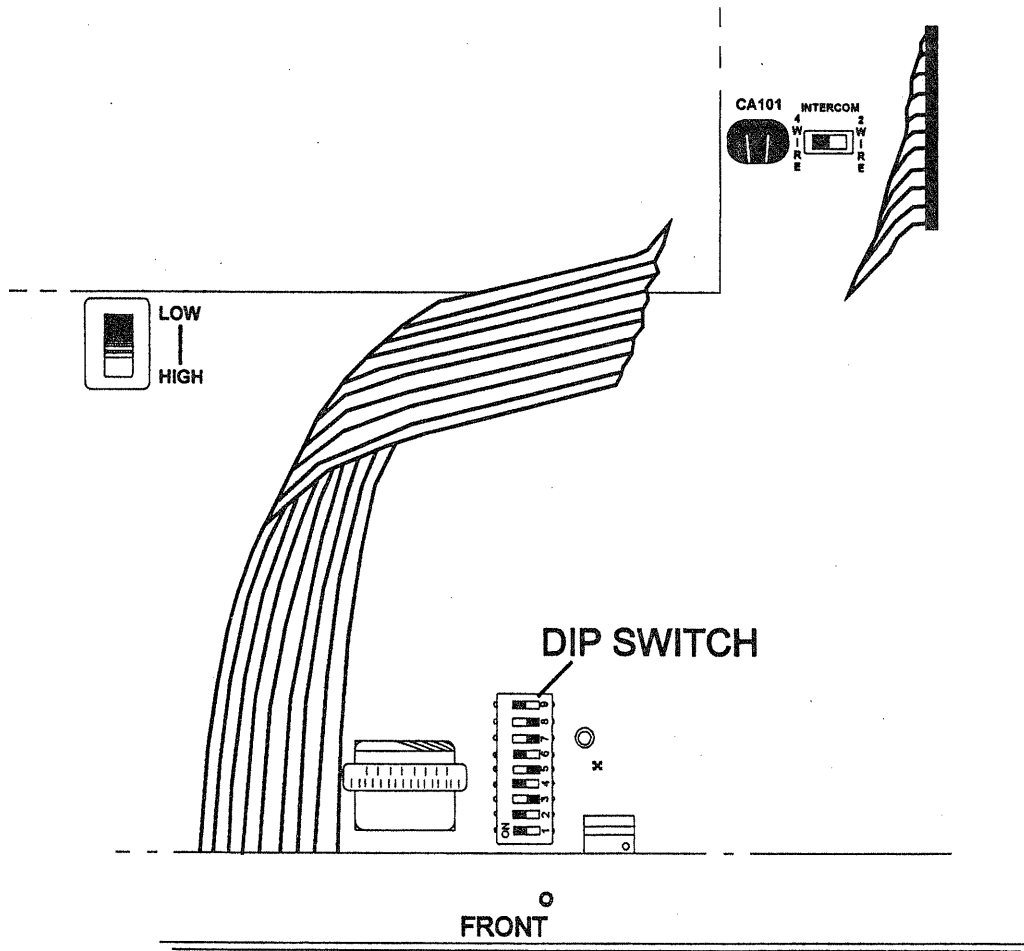

**Figure 8**  
**Internal Intercom Switches**



## RACK MOUNTING

To rack mount the BTR-300 base transceiver do the following:

Remove the front two #6-32 x 3/8" screws on each side of the transceiver as shown in Figure 9.

Place the rack mount brackets (supplied) on either side of the unit and insert three #6-32 x 3/8" screws for each bracket. Tighten the screws securely.

Insert the BTR-300 into your 19" rack enclosure and insert four (4) #10-32 x 3/8" Phillips pan head screws (supplied) in each corner of the rack mount brackets and secure to your enclosure.

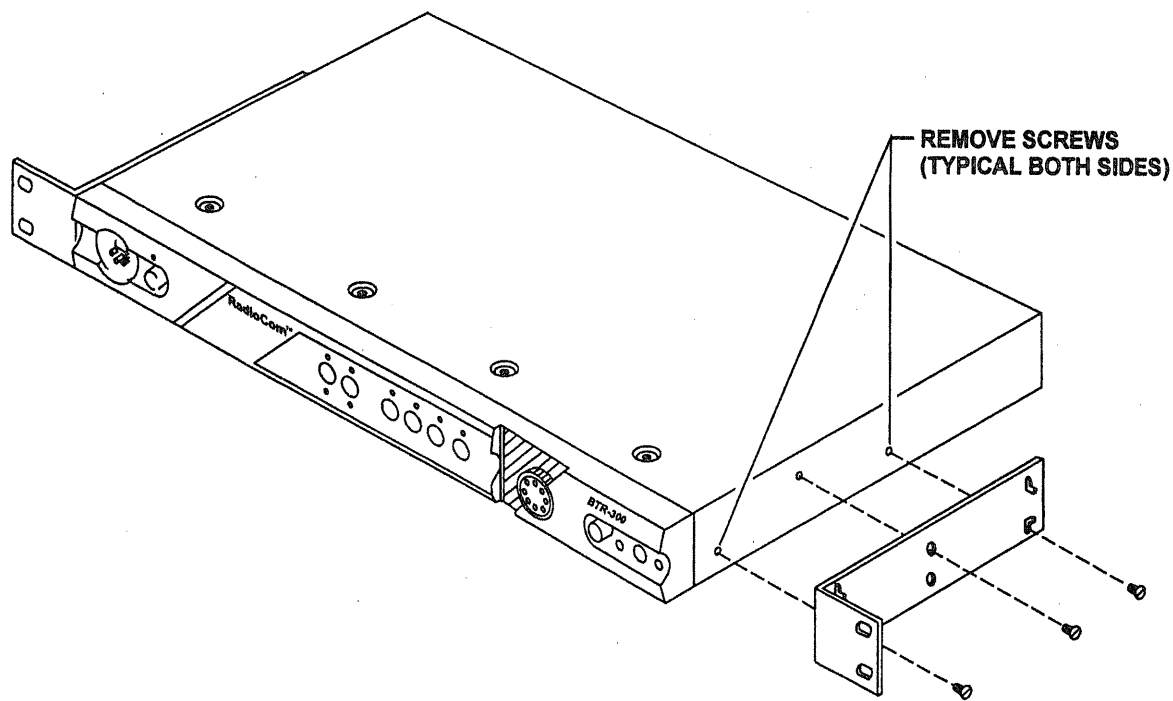

**Figure 9**  
**Attaching Brackets for Rack Mounting**

## ANTENNA INFORMATION

### ANTENNA CONNECTIONS

The BTR-300 is supplied with two (2) antennas. One 5/8-wave antenna for Transmit and one 5/8-wave antenna for Transmit and one 5/8-wave for Receive.

Assemble the 5/8-wave antenna by screwing the two sections together as shown in Figure 10. Both sections of the BTR-300 5/8-wave antennas must be used. Leaving off the top section will result in reduced range.

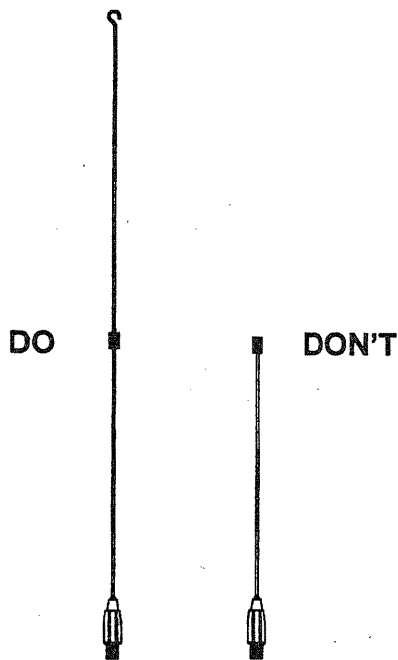

**Figure 10**  
**5/8-wave Antenna Assembly**

To insure that the frequency of the antennas match the receiver and transmitter of the BTR-300, match the color dot on the antenna with the color dot on the BTR-300.

Attach the antennas to the antenna input receptacles unless the BTR is rack mounted. Tighten the connector securely.

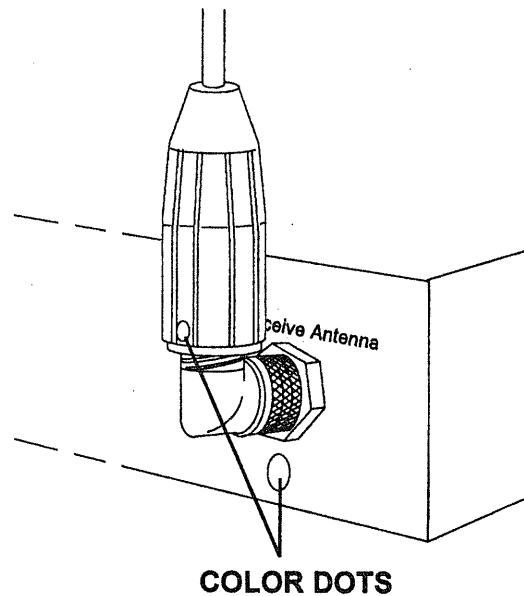
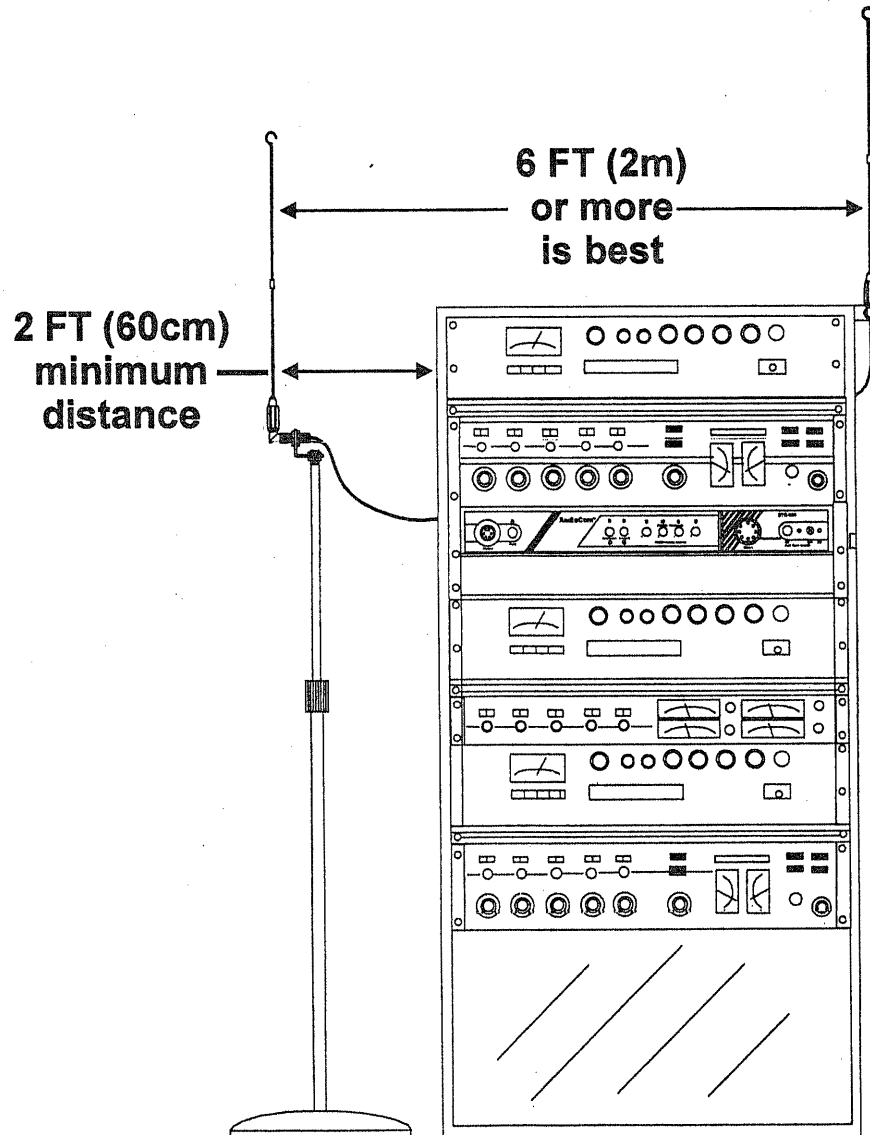

**Figure 11**  
**Attaching 5/8-wave Antenna**

**Remoting Antennas:** It will be necessary to remote both the transmit and receive antennas on the BTR-300 when it is rack mounted.

Connect the coax cable assembly (not supplied), to the receive antenna receptacle and mount the 5/8-wave antenna. The antenna can be attached to either a wall mount bracket or a microphone stand bracket (not supplied). See "Accessory" section for order information.

You will also need to remote the transmit antenna in the same manner. Connect a coax cable assembly to the transmit antenna receptacle. Mount the 5/8-wave antenna by attaching it to a bracket (not supplied).



**Figure 12**  
**Remoting Antennas when Rack Mounted**

## ANTENNA POLARIZATION

The Telex Wireless Intercom System is “Vertically Polarized”. This means both the transmitting and receiving antennas should operate in the vertical position.

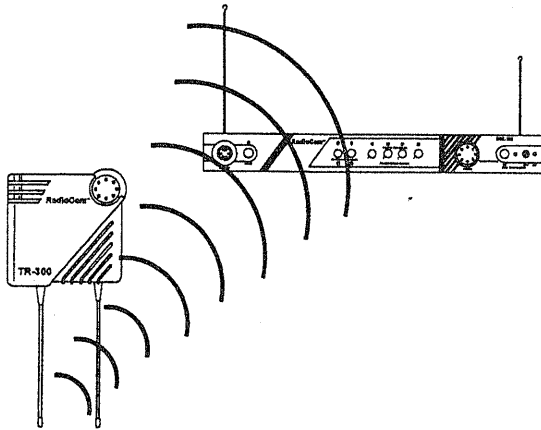

**Figure 13**  
**Vertically Polarized Antennas**

## ANTENNA PLACEMENT

Proper antenna placement probably has the most effect on you TELEX Wireless intercom System’s overall performance. The following suggestions will result in optimum performance.

Proper placement of the TR-300 can be critical. The trailing antennas should “dangle” freely. “Wadding” the antennas up and placing them in a pocket, etc., will reduce system range.

It is suggested that the unit be worn on the belt or pocket with both antenna’s hung vertically for best operating range and performance.

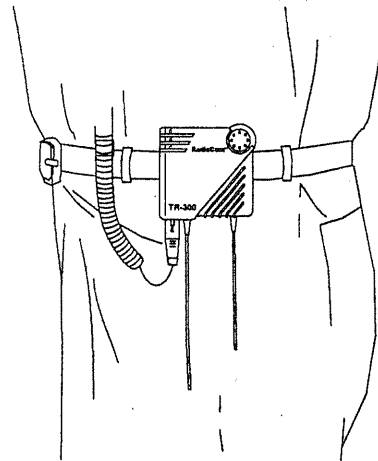

**Figure 14**  
**Proper Dressing of the Antennas**

Keep the distance between the base (BTR-300) and the belt pack (TR-300) antennas as short as possible. The greater the distance, the weaker the signal. However, the portables should be a minimum distance of 10 feet from the base station and each other for best performance.

Make sure the “signal paths” between the BTR-300 and remotes are unobstructed. You should always be able to visibly locate the an-

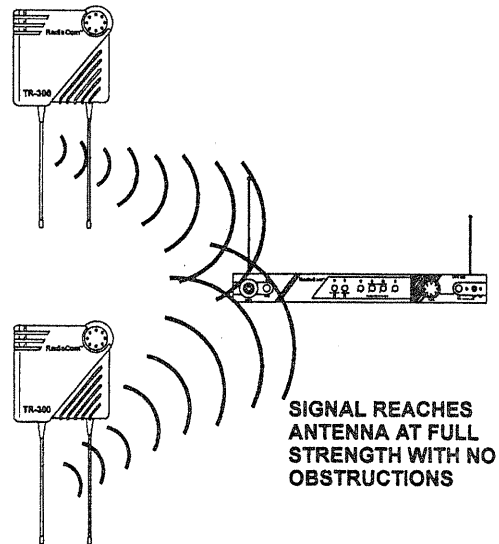

**Figure 15**  
**Keeping Site Clear to Antenna**

Attempting to operate the wireless intercom system through or around walls, ceilings, metal objects, etc. will reduce system range and performance.

**SIGNAL REFLECTION OFF A METAL OBSTRUCTION CAUSES REDUCED SIGNAL AND "MULTIPATH"**

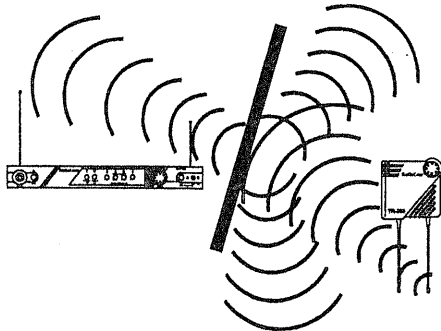

**Figure 16**

**Operating System Near Obstructions**

<p>1. Placing the unit in an equipment rack and removing the antennas is GOOD.</p>	<p>2. Placing the unit on top of a shelf or equipment rack unobstructed without removing the antennas is GOOD.</p>	<p>3. Placing the unit in an equipment rack with the antennas mounted on the BTR-300 or the side of the rack is BAD.</p>
--	--	--

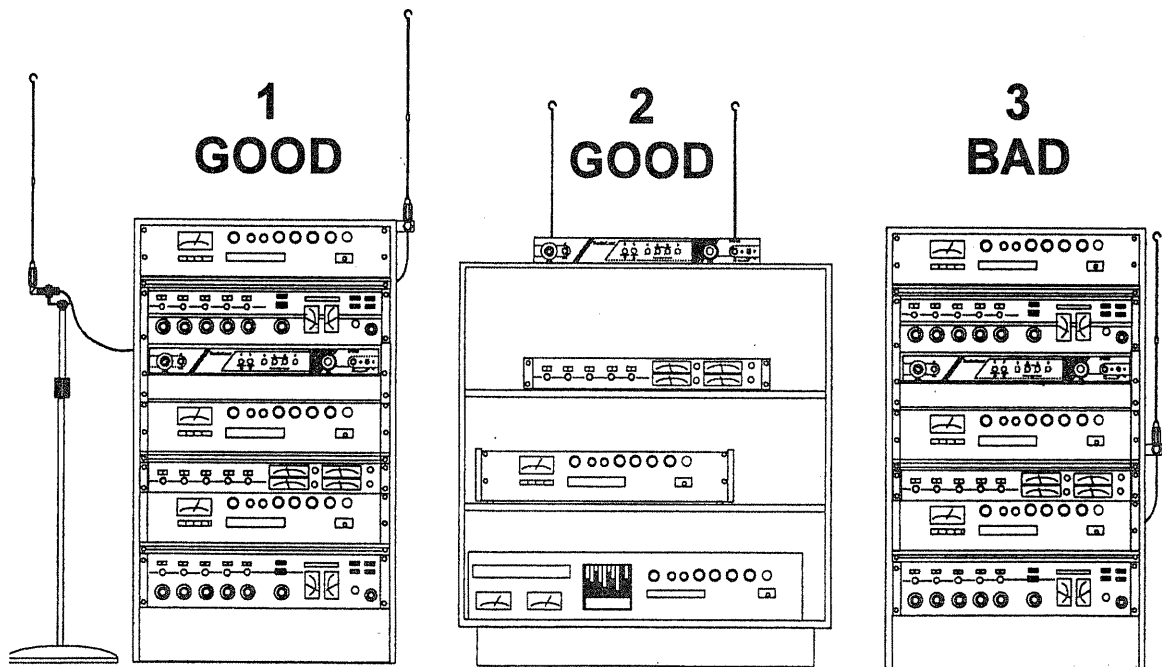

**Figure 17**

**BTR-300 Antenna Placement**

## LOCAL HEADSET CONNECTION

Insert the headset/microphone into the 4 pin XLR connector on the front panel. See the microphone connection diagram (Figure 2) if other than a Telex Headset is used.

## HEADSET MICROPHONE SELECT SWITCH

If the headset you are using has an Electret microphone, the local microphone select switch must be in the "ELT" position (Electret). This switch is located on the rear panel. A +5 volt bias is available at the microphone plug for electret use.

If you are using a headset with a dynamic microphone, place the local microphone select switch in the "DYN" position (Dynamic).

**NOTE: FOR PROPER OPERATION YOU MUST MATCH THE TYPE OF MICROPHONE YOU ARE USING WITH THE DYNAMIC/ELECTRET SWITCH LOCATED ON THE REAR OF THE UNIT.**

## TRANSMIT SWITCH

Allows the operator to select three different types of transmitting modes; continuous transmitter, transmitter off, or remote transmitter. For most operations, place the transmitter switch in the "CONT" position (Continuous mode).

In the *Continuous* mode the transmitter will be on at all times regardless of whether the portables are on or not.

In the *Remote* mode, the only time the base can transmit is when a portable unit is turned on.

In the *Off* mode the BTR-300 base station will not transmit to the remote belt-packs. This mode might be used if the base is to be a monitor station only.

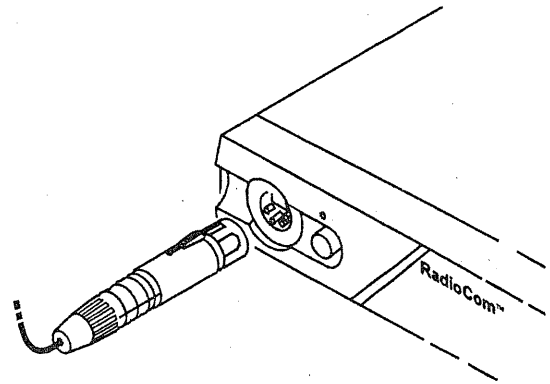

**Figure 18**  
**Connecting Headset to the BTR-300**

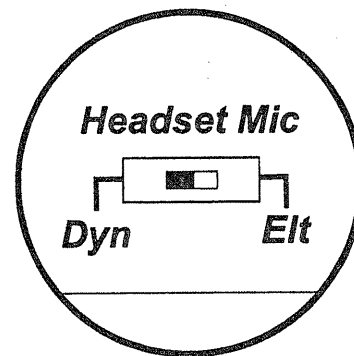

**Figure 19**  
**Headset Microphone Select Switch**

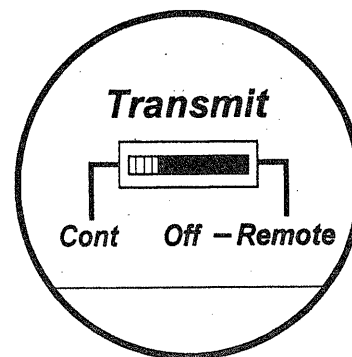
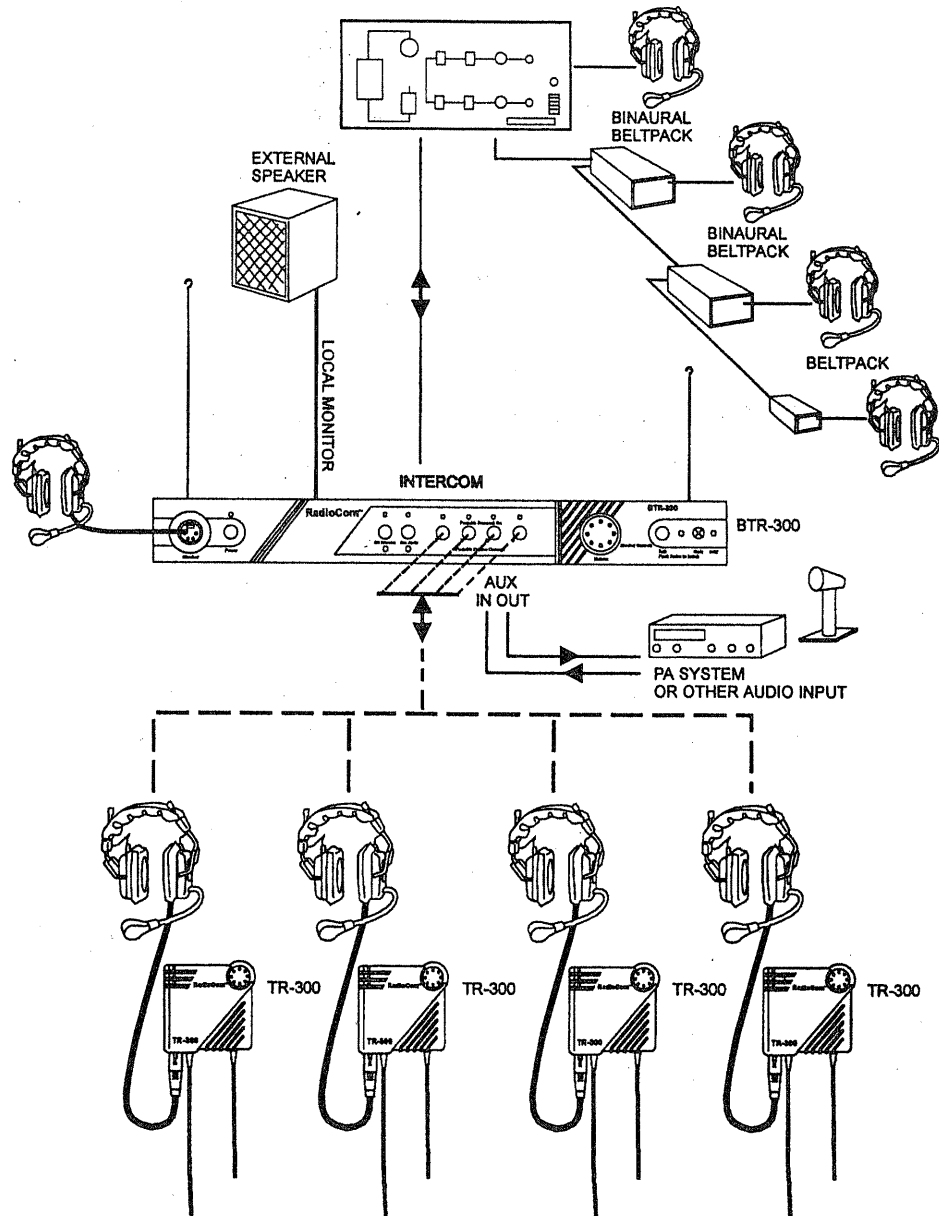

**Figure 20**  
**Transmit Switch**

## INTERCONNECTION to a HARD-WIRED INTERCOM SYSTEM

The RADIOCOM wireless system can be integrated into Telex intercom systems and most existing wired intercom systems including RTS and Clearcom.

Connect the intercom cable to the back of the BTR-30. There are two intercom connections on the back of the unit, one being a male connector, the other a female connector, connected in parallel with each other. Either works as an input or output.



**Figure 21**  
Typical Interface to Wired System

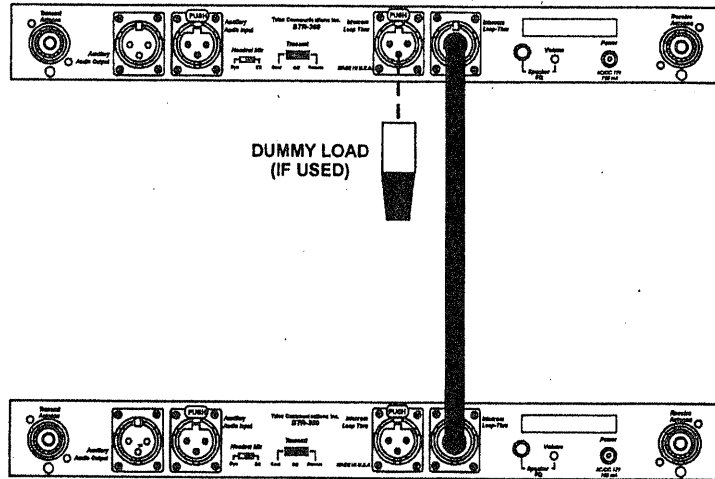

**Figure 22**  
**Connecting Two BTR-300's**

**CONNECTING AUXILIARY AUDIO SYSTEM**

Connect the BTR-300 to your auxiliary audio via the Auxiliary input/output receptacles on the rear of the unit.

**CONNECTING BTR-300's**

Connect the first BTR-300 to other BTR-300s by using short XLR type cables (not supplied) plugged into either of the intercom jacks. See Figure 22.

Note that the stations need to be on different frequencies.

**POWER CONNECTION**

Insure the Power ON/OFF Switch on the front of the BTR-300 is in the "OFF" position. Connect the AC power supply cord to the BTR at the socket labeled "POWER". Plug the power supply unit into an AC outlet.

**DUMMY LOAD**

In the case where a wired intercom will not be used with the BTR-300, it is important that the dummy load (supplied) be installed. The dummy load should be plugged into the "Intercom Loop-Thru" connector. See Figure 22.

**NOTE:** If the dummy load is not used an annoying squeal may result that may cause damage to the ears.

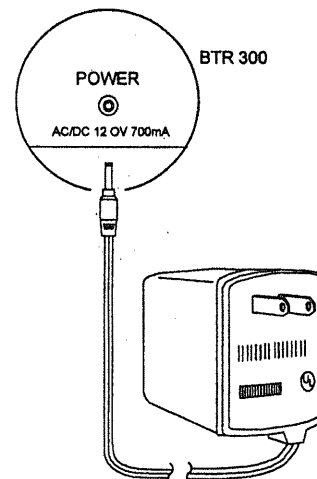

**Figure 23**  
**Connecting the Power Supply**



## TR-300 SET-UP

### HEADSET CONNECTION

Inset the headset/microphone into the connector on the bottom of the unit. See the connection diagram (Figure 5) if headsets other than Telex are used.

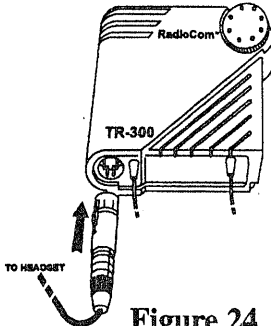

Figure 24  
Connecting Headset

### DYNAMIC/ELECTRET SWITCH

If the headset you are using has an electret microphone, the dynamic/electret switch must be in the "E" position. This switch is accessible by removing the belt clip and removing the battery holder. A +5 volt bias is available at the microphone plug for electret use.

If you are using a headset with a dynamic microphone, place the dynamic/electret switch in the "D" position.

**NOTE:** for proper operation you must match the type of microphone you are using with the dynamic/electret switch located inside the battery compartment.

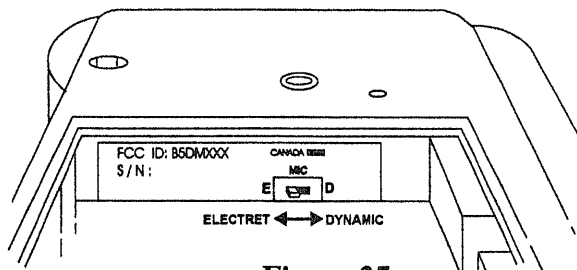

Figure 25  
Dynamic/Electret Switch

### BATTERY INSTALLATION

Insure that the OFF/ON Volume control knob is turned OFF. Access the battery compartment by removing the belt clip on the back of the unit. Release the 1/4 turn fastener located on the back of the belt clip and remove belt clip/cover.

Remove the battery holder from the box. Insert six (6) AA batteries in the holder, paying close attention to polarities of the batteries. It may be necessary to turn the batteries with the thumb and forefinger the first few times the batteries are inserted into the battery holder to insure good positive contact. Insert the holder into the case and replace the belt clip/battery cover and engage the 1/4 turn fastener.

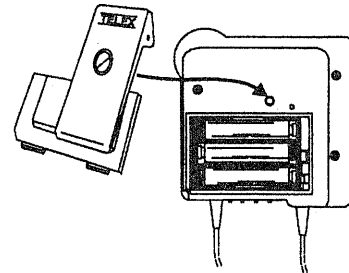

Figure 26  
Battery Installation

**NOTE:** For maximum uninterrupted service it is suggested that new 1.5 volt alkaline AA batteries be installed prior to each use. Avoid "shelf worn" or "economical" batteries. Operation from nickel metal hydride batteries is also permissible. Typical life of fresh alkaline batteries with the TR-300 is approximately 24 hours maximum, 15-17 hours is typical of fully charged nickel-metal hydride batteries.

**NOTE:** Rechargeable batteries can be charged right in the TR-300 using the Telex BC-300NM1 Battery Charger. Refer to "Battery Information" Section. Rechargeable batteries in the holder can be charged using the Telex BC-300NM2 charger.

# PRE-WALK-THRU CHECKLIST

Following the instructions fully to this point, you have successfully completed the following checklist:

- Set (if necessary) the internal intercom switches to correspond with the wired intercom.
- Located the BTR-300 transceiver properly.
- Connected power to BTR-300 transceiver.
- Connected the antennas to the BTR-300 with matched color codes.
- Set Dynamic/Electret switches in both BTR-300 and TR-300.

- Set transmit switch on BTR-300.
- Connected headsets to BTR-300 and all TR-300's.
- Connected the BTR-300 to any auxiliary audio, intercom or external speaker.
- Installed batteries in the TR-300 Remote Transceiver.

If you missed any of the above instructions, go back and complete that instruction before going on.

# SYSTEM OPERATION

## BTR-300 OPERATION

### POWER

If you have followed the instructions until this point, you should now be ready to turn both the TR-300 and the BTR-300 "ON".

Place the power switch on the BTR-300 in the "ON" position. The red power on indicator light should illuminate.

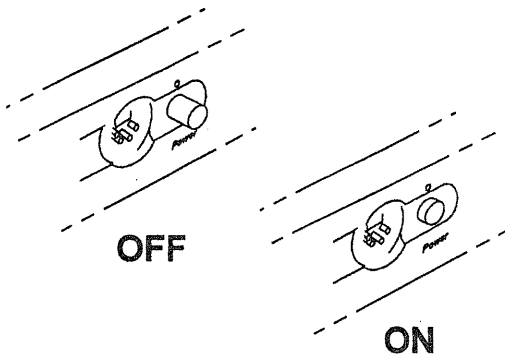

Figure 27  
Power ON/OFF - Volume Control Knob

### LOCAL HEADSET VOLUME

Adjust the volume control on the BTR-300 by rotating the volume control either clockwise or counterclockwise as required for comfortable listening volume.

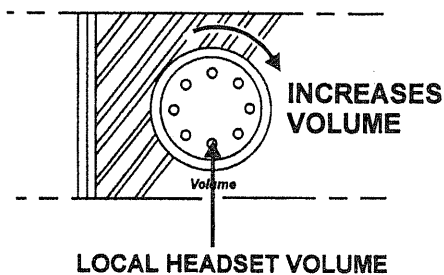
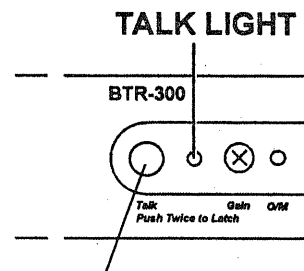

Figure 28  
Volume Control - BTR-300

### PUSH TO TALK/LOCK-TO-TALK SWITCH

To enable the talk function on the BTR-300, press and hold down on the talk button and begin talking. Releasing the talk button will discontinue the microphone audio. For continuous talks, quickly press the talk button twice. This enables the talk function as long as you want. To release the talk function press the talk button once more and the talk function will cease.

**NOTE:** The talk light will be illuminated whenever the talk function is activated.



### PUSH TO TALK LOCK TO TALK SWITCH

Figure 29  
Push-to-Talk/Lock-to-Talk Switch

## TR-300 OPERATION

### POWER

You should now be ready to turn the TR-300 "ON". Rotate the OFF/ON Volume Control Switch on the TR-300 clockwise to turn the unit on.

### BATTERY CHECK

As you turn the unit on, note that the battery light (labeled bat/ovmod) should flash one or more times with good batteries. Low batteries will cause the light to be illuminated continuously and a bad battery will not cause any illumination at all.

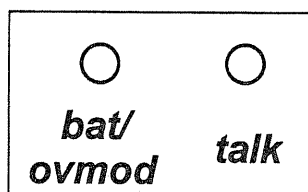

Figure 30  
Low Battery/ Overmodulation  
and Talk Indicator Lights

### HEADSET VOLUME

After batteries have been checked, adjust the volume control by rotating the control as required for comfortable listening volume.

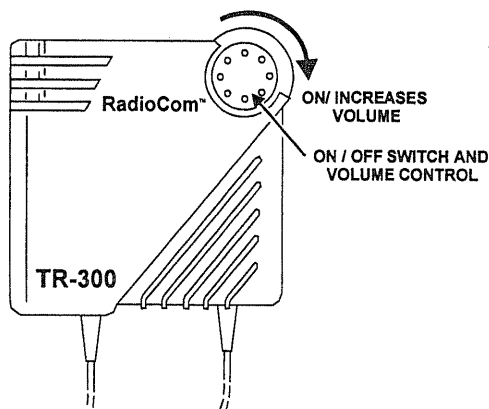

Figure 31  
Power ON/OFF - Volume Control - TR-300

### PUSH TO TALK/PUSH TO TRANSMIT

To enable the talk function on the Model TR-300 press and hold down on the talk button and begin talking. Releasing the talk button will discontinue the microphone audio. For continuous talk, quickly press the talk button twice. This locks on the talk function. To release the talk function press the talk button once. Note that the TR-300 transmits any time that the power is on.

**NOTE:** The talk light will be illuminated whenever the talk function is activated.

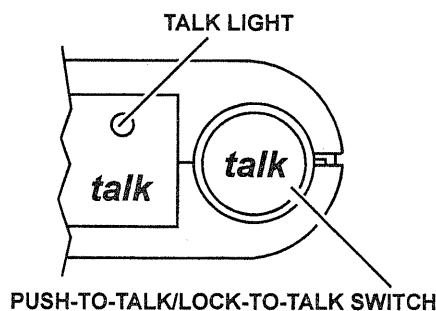

Figure 32  
Push-to-Talk/Lock-to-Talk Switch

## ENABLING AUDIO

### PORTABLE TRANSCEIVERS

Select the TR-300 portables that will be used with the BTR-300. Push in the portable enable switches that correspond to the TR-300 remotes that you will be using. The numbers of the portable stations (1, 2, 3, and 4), are the last digit of the product number on the back of the TR-300. The Portable Transmit On light will illuminate when the remote on that frequency is turned on. The indicators may also light in response to outside interference on that channel or to intermodulation arising from portables being used at too close a distance to the base. To prevent these sources from creating undesirable noise, all unused channels should be disabled.

### INTERCOM SWITCH

The intercom switch in the front of the unit will act as an enabling switch when the unit is being used with either a Telex Audiocom wired intercom or Clearcom wired intercom.

When using a RTS system wired intercom the switch will act as a channel selector switch for selecting of either channel 1 or channel 2.

### AUXILIARY

The AUX Switch on the front of the BTR-300 will enable any auxiliary audio input (or 4 wire intercom) that is supplied to the unit.

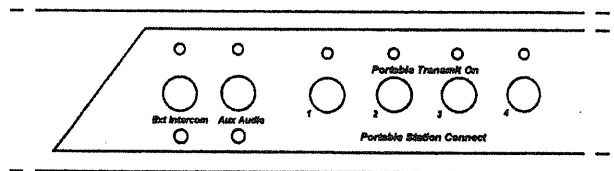

**Figure 33**  
**Enable Switches**

# SETTING SYSTEM GAIN LEVELS

## ADJUSTING GAIN

The gain may need to be adjusted for various audio conditions. The overmodulation light will indicate when the gain is too high. If the light is illuminated when you are talking, the gain is too high and will need to be decreased. If the light does not flash at all, and the audio is low, the gain may need to be increased. An occasional flash of the overmodulation indicator is fine.

Using a plastic screwdriver (supplied), adjust the control clockwise to increase the gain or counterclockwise to decrease the gain. Note that the gain can also be adjusted by changing the spacing between the microphone and your mouth.

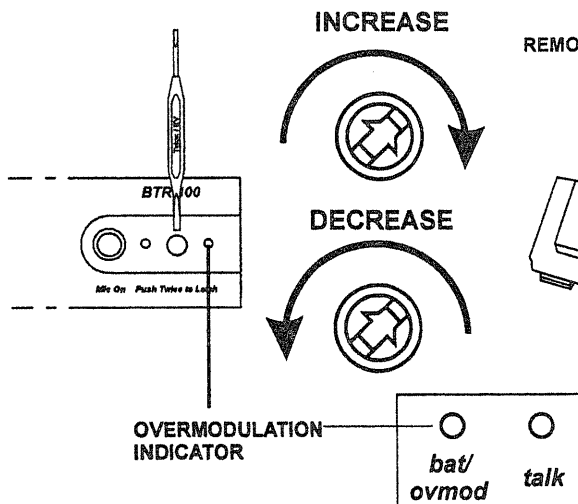

Figure 34  
Adjusting Microphone Gain - BTR-300

## BTR-300 BASE STATION

The microphone overmodulation indicator light for the BTR-300 headset can be found on the right side of the front panel. The microphone gain control potentiometer is located to the left of the indicator light.

## TR-300 PORTABLE

The overmodulation circuitry in the TR-300 uses the same light as the low battery circuitry. If modulation is too high this light will illuminate when talking.

If the gain needs to be adjusted, remove the belt clip on the rear of the unit and pry out the small rubber plug to the right of the screw boss. This will reveal the microphone gain control potentiometer. Once adjusted, replace the rubber plug.

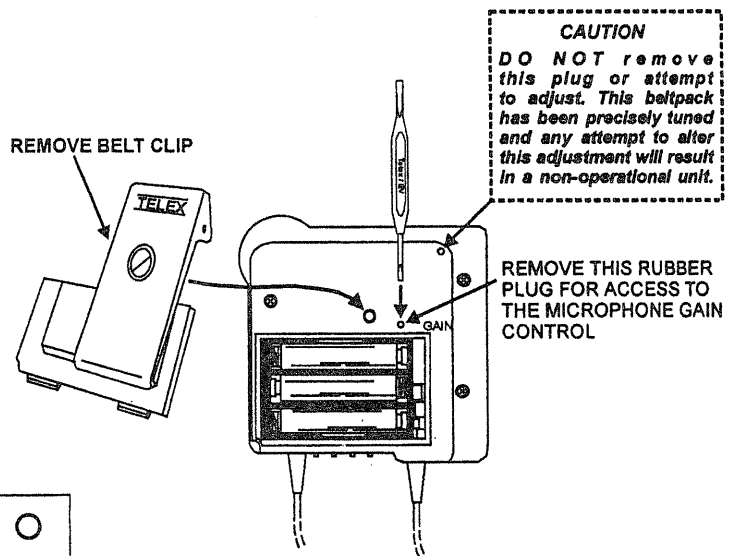
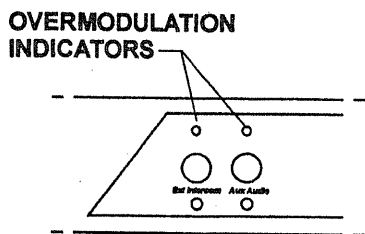

Figure 35  
Adjusting Microphone Gain - TR-300

## INTERCOM GAIN

If the audio volume at the intercom input is too high, the light will be illuminated when the person on the intercom is talking. Decrease the gain until the light does not illuminate while talking at normal volume. Occasional flashing of the light is allowable. See Figure 36.



**Figure 36**  
Auxiliary Gain controls

## AUXILIARY GAIN

If the audio volume at the auxiliary input, is too high, the Aux light will be illuminated when the person on the auxiliary is talking. Decrease the auxiliary gain until the auxiliary light does not illuminate while talking at normal volume. Occasional flashing of the auxiliary light is allowable. The auxiliary indicator has three states: OFF, HALF BRIGHT, and FULL BRIGHT. When the switch is "OUT", the indicator is OFF. When the switch is "IN" it becomes HALF BRIGHT, and when the input is overmodulated it becomes FULL BRIGHT.

# SYSTEM WALK-THRU

Now that you have successfully "set up" your RadioCom Wireless Intercom System and turned on any auxiliary equipment you are ready to test the overall performance by "Walking" the RadioCom system through the areas in which you will be using it.

Before you begin your walk-thru check the following:

- TR-300 Battery Check.
- Set microphone gain in both the TR-300 and the BTR-300.
- Check that the push-to-talk switches are engaged in the Lock-to-talk position and the light is illuminated.
- Portable units to be used are enabled at the Base.

The "system walk-thru" can detect problems of weak signal strength caused by:

- Poor antenna location.
- Wrong antenna for receiver and/or transmitter.
- RF "Trouble Spots."
- Operating distance beyond system capability.
- Old or used batteries in the TR-300.

Under normal conditions the Portable Transmit On lights on the BTR-300 should always be lit when portables are transmitting. "Weak Signal" conditions will result in flashing of the Transmit light.

In 99% of all instances you will set up your RadioCom Wireless Intercom System, walk it through and achieve error-free performance. If in the rare instance your RadioCom System does not "pass" during your walk-thru evaluation, refer to the last section of this manual which deals with system troubleshooting.

# TROUBLESHOOTING

Reread the sections of this manual to make sure you have completed system set-up properly.

If you are unable to solve the problem, contact the dealer from whom you purchased the system for assistance.

PROBLEM	SOLUTION
<b>DISTORTION</b> - System's audio quality seems distorted at medium to high input levels.	Reduce microphone gain by adjusting microphone gain control.
<b>HISS</b> - System seems to produce a "hiss" which is undesirable.	Check the gain setting on all beltacks and the base. They may be too low.
<b>LOW OUTPUT</b> - System produces a low output level.	Check the gain setting on both the beltacks and the base. They may be too low.
<b>FEEDBACK</b> - Moving around area of use produces "squeal" or "howl" in various location using ext. speakers.	Reduce the gain settings on both the beltacks and the base. They may be too high.
<b>DROPOUTS</b> - When moving around the area of use there seems to be locations where the signal "swooshes" or completely disappears.	Make sure both antennas on the base are connected and follow the location suggestions. Change the location of the base unit and antennas or avoid the bad areas with the remote beltacks.
<b>INTERFERENCE</b> - System picks up signals other than wireless Intercoms.	<p>Make sure the TR-300 beltack is turned on - this will usually eliminate the interfering signal. If not using a beltack, make sure the corresponding enable switch at the base is disengaged.</p> <p>If problems persist with the TR-300 beltack on, you will probably need to have your system's frequency changed to another channel.</p>
<b>NO AUDIO</b> from BASE or BELTPACK headsets.	Check Transmitter switch on base, use CONT or REMOTE position. Check push-to-talk function - is the switch ON?



# BATTERY INFORMATION

## GENERAL

Improper battery selection, use, installation, and care are the cause of numerous wireless system failures.

**Alkaline Batteries:** Alkaline batteries such as Mallory's DURACELL or Everready's ENERGIZER provide the most reliable operation in wireless transceivers. The use of low cost carbon-zinc batteries is NOT recommended.

## BC-300NM1 BATTERY CHARGER

**NOTE:** The BC-300NM1 is not supplied with the TR-300. See the "Accessory" section for ordering information.

**CAUTION**  
DO NOT ATTEMPT TO CHARGE  
ANY ALKALINE BATTERIES WITH  
THIS CHARGER.

The BC-300NM1 will charge nickel-metal hydride batteries in a TR-300. Insert the plug from the charger into the jack on the side of the TR-300 and plug the charger into a 110 volt outlet.

Full charge of the battery pack is obtained after 12 to 14 hours. A full charge will last 15-17 hours with nickel metal hydride batteries.

Extensive over-charging may damage or destroy the batteries. Please ensure the charging time does not exceed 24 hours.

Unplug the charger when not in use.

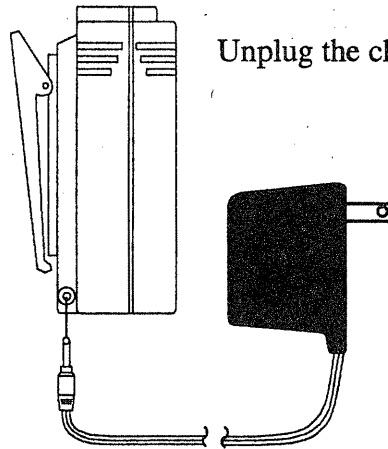

**Figure 37**  
**BC-300NM1 Battery Charger**

ENERGIZER® is a registered trademark of Union Carbide Corporation.  
DURACELL® is a registered trademark of Duracell Inc.

## BC-300NM2 BATTERY CHARGER

**NOTE:** The BC-300NM2 is not supplied with the TR-300. See "Accessory" Section for ordering information.

Remove the battery holder from the TR-300.

**CAUTION**  
DO NOT ATTEMPT TO CHARGE  
ANY ALKALINE BATTERIES WITH  
THIS CHARGER.

Snap the terminal connector onto the battery holder and plug the charger into a 110 Volt outlet.

Full charge of the battery pack is obtained after 12 to 14 hours. A full charge will last 15-17 hours with nickel-metal hydride batteries.

Extensive over-charging may damage or destroy the batteries. Please ensure the charging time does not exceed 24 hours.

Unplug the charger when not in use.

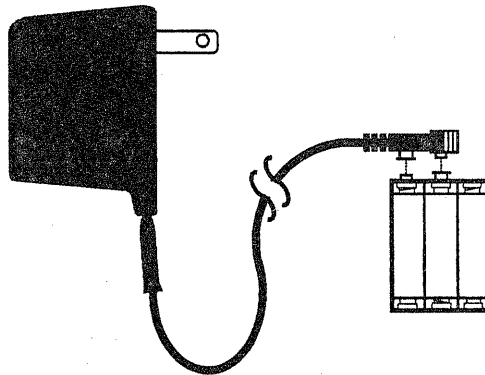
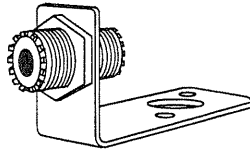

**Figure 38**  
**BC-300NM2 Battery Charger**

# ACCESSORIES

**AB-300 Microphone Stand/Surface Mount Bracket - for 5/8-wave antenna.**  
Includes necessary hardware.

Order No. 63906-100



**25' Coax Cable**

Order No. 63901-000

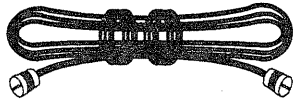

**4' Coax Cable**

Order No. 63901-001

**5/8-Wave Antenna -**

Screw apart for easy storing.

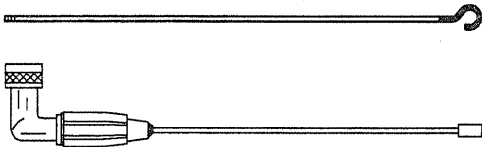

Order No.	Color Code	Frequency Range
879248-1	Blue	150-168.9 MHz
879248-2	Yellow	169-184.9 MHz
879248-3	White	185-199.9 MHz
879248-4	Red	200-216 MHz

**AC Power Supply 12 Volt, 60 HZ**

Order No. 730139-000

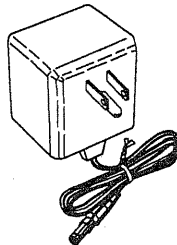

**BC-300NM1 Battery Charger -**  
Order No. 70741-001

Includes 6 nickel-metal hydride batteries and 1 carrier. Charges a TR-300 without removing the battery pack.

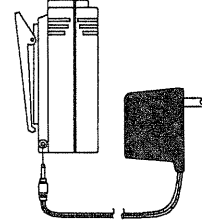

**BC-300NM2 Battery Charger**  
Order No. 70741-002

Includes 6 nickel-metal hydride batteries and 1 carrier. Charges 1 set of batteries outside of the TR-300.

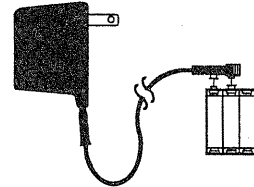

**NMBP Battery Pack**

Order No. 70741-003

6 nickel-metal hydride batteries and carrier.  
For use with BC-300NM1 and BC-300NM2.

**Headsets**

**Telex Configuration**

Order No.

PH-44 . . . . .	300853-100
PH-88 . . . . .	300852-100
HR-1 . . . . .	300534-007
HR-2 . . . . .	300534-000

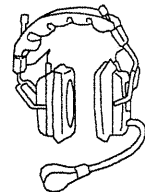

**RTS Configuration**

Order No.

PH-44R . . . . .	300853-101
PH-88R . . . . .	300852-101
HR-1R . . . . .	300534-008
HR-2R . . . . .	300534-001

# CUSTOMER SERVICE INFORMATION

If your receiver or transmitter should need servicing under the warranty, please contact:

Customer Service Department  
TELEX COMMUNICATIONS, INC.  
8601 East Cornhusker Highway,  
P.O. Box 5579,  
Lincoln, Nebraska 68505-5579 U.S.A.  
Phone: (402) 467-5321 or 465-7021

All claims of defect or shortage should be sent to the above address. When returning items for service, you must provide date and proof of purchase, such as a copy of the sales receipt, to establish warranty. A letter should be included outlining all symptoms and claimed defects. Information on how the equipment was installed and used is very helpful. Please include your phone number and return address in case our service technicians need to contact you.

Units that have been modified cannot be accepted for repair.

Include all information requested by the Service Department. Then pack the unit as follows:

Check the unit to see that all parts and screws are in place. Then wrap it in heavy paper or put it in a plastic bag. If the original carton is not available, place the unit in a strong carton that is at least six inches bigger in all three dimensions than the unit. Fill the carton equally around the unit with resilient packing material (shredded paper, foam, etc.). Seal it with gummed paper tape, tie it with a strong cord, and ship it by prepaid express, United Parcel Service or insured parcel post to the Telex Service Department.

It is very important that the shipment be well-packed and fully insured. Damage claims must be settled between you and the carrier and this can delay repair and return of the unit to you.

Telex reserves the right to make changes in design and improvement on its product without assuming any obligation to install the same on any of its products previously manufactured. Further Telex reserves the right to ship new and/or improved products which are similar to the form, fit and function of products originally ordered.

## FCC INFORMATION

The Telex Models BTR-300 and TR-300 transceivers are Type Accepted under United States Federal Communications Commission Parts 90 and 74. Licensing of Telex equipment is the user's responsibility and licensability depends upon the user's classification, user's application, and frequency selected. Telex strongly urges the user to contact the appropriate telecommunications authority before ordering and choosing frequencies.

**CAUTION:** Changes or modifications made by the user could void the user's authority to operate the equipment.

**TELEX<sup>®</sup>**

---

TELEX COMMUNICATIONS, INC. 12000 Portland Ave. South, Burnsville, MN 55337, U.S.A.

PN 803008-1

AUG 2000

Made in U.S.A